

“There is no sound barrier”™

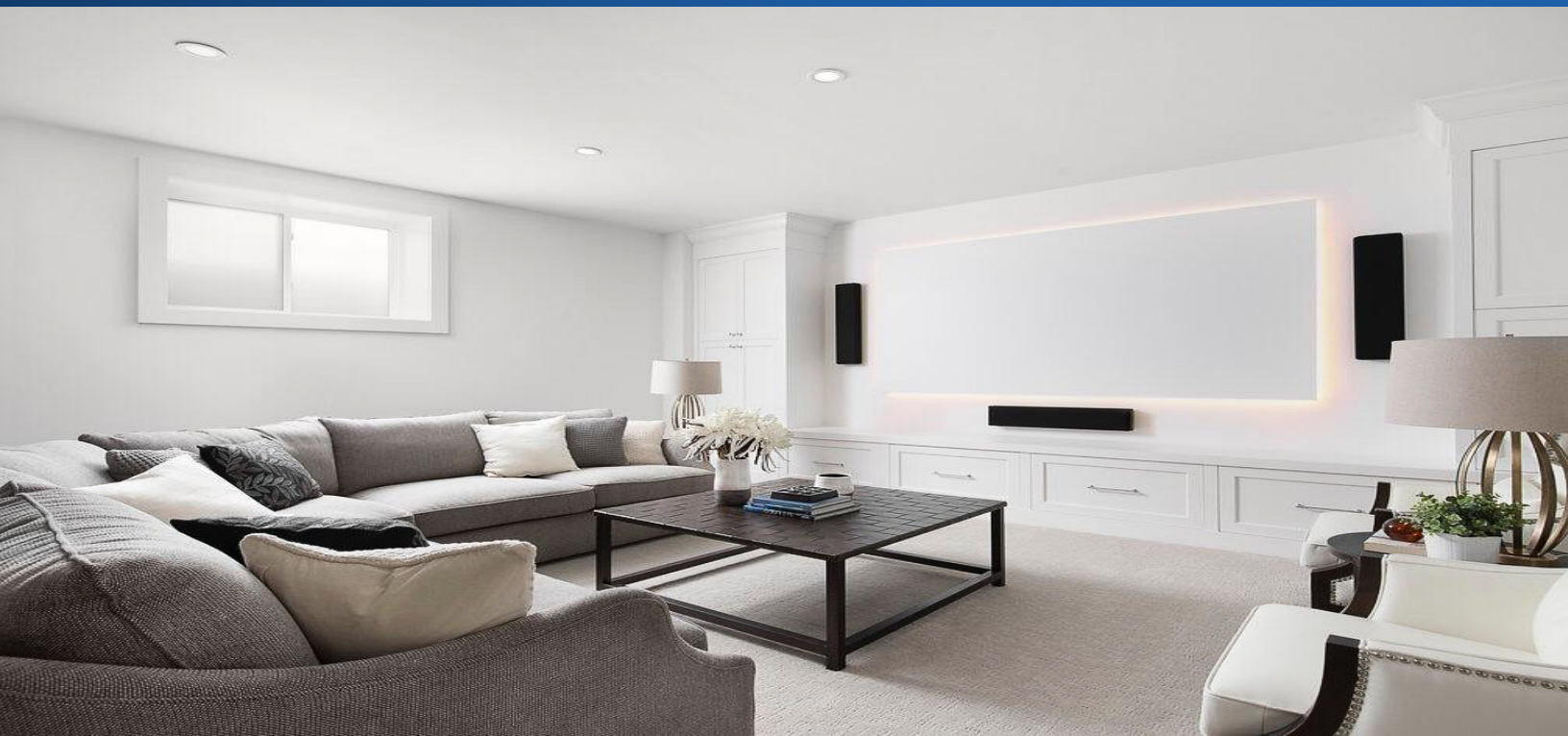

SUONO

Angstrom
LOUDSPEAKERS

Introduction to Elegant On-Wall Loudspeakers

Flat Panel Versatility

The flat screen TV is one of the technological marvels of our generation. SUONO On-Wall loudspeakers from Angstrom are the TV's ideal compliment for their audio performance and elegant lifestyle compatibility. Their industrial design graces the thinnest of TV's - while their audio performance satisfies discerning audio enthusiasts. The SUONO Series is one of the best ways to magnify the sound and performance of your home entertainment experience. The Suono blend of sleek styling, awesome audio and ease of installation is unsurpassed.

SUONO is a remarkably flexible range of On-Wall loudspeakers purpose-built for Stereo, Home Theatre and Custom-Installation applications. Designed from the ground up, every aspect of the Suono family is dedicated to optimize their performance: cabinets are crafted from dense MDF, covered with acoustically transparent cloth, designed with contemporary looks and crafted with durable, attractive finishes.

Technically, SUONO loudspeakers use twin mid/bass drive units for higher power handling and increased acoustic output - ideal for home theater and musical enjoyment. SUONO loudspeakers all come with carefully designed brackets that attach easily, yet provide ample strength and support. Wherever floor-standing solutions are required, optional free-standing plinths are available for the 200S, 300S, 400 II, 500S and 600DS models.



Special Features

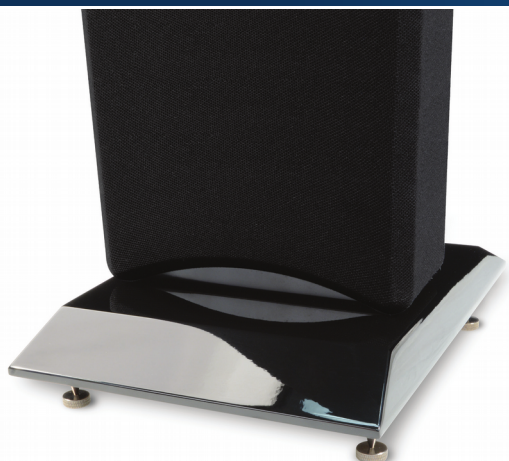

Optional Plinths

- These high-gloss plinths add elegance to any freestanding installations.
- Hardwood floor discs and carpet spikes included.
- Available for 200S, 300S, 400II, 500S and 600SD in Black, Silver or White high gloss finish.



Easy Installation Design

- SUONO speakers secure easily to any wall in just minutes. No big holes to cut.



Thin Cabinet Design

- Inert 3" thin MDF cabinets house high-performance drivers.
- Tune-able ports optimize acoustic dynamics in any room.
- Acoustically transparent Black cloth covers the cabinet and drivers.



*** Silver and White optional



Solid and Secure Connection

- Gold-plated, High-Pressure Spring-terminals hide from sight and keep connections secure.



Special Feature – 100SD

- The Toggle hidden between terminals can make a 6-decibel cut (0db -6dB) in the sound level of the front tweeter.



Design Specifications



Matched pair of **SUONO 600SD** works as Left and Right speakers and as a Stereophonic Center Channel. Two panels as Three speakers.

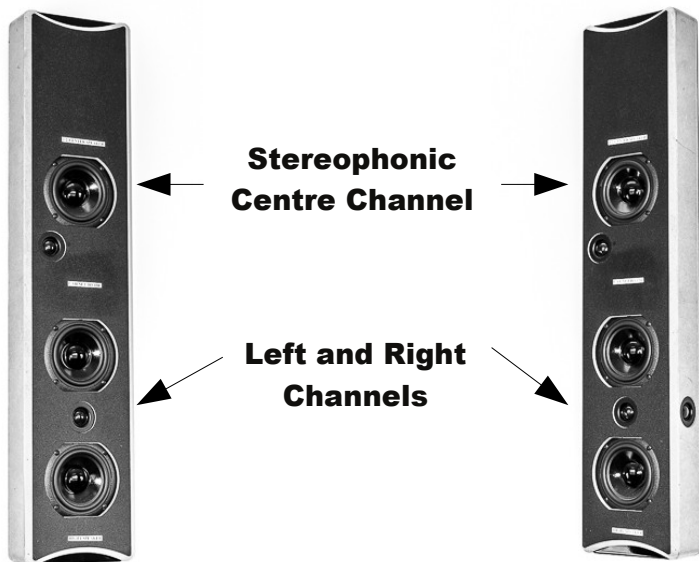

SUONO 500S is Angstrom's most advanced on-wall loudspeaker design. High quality components are utilized in this remarkable system producing outstanding dynamic range. Symmetrical configuration of drivers allows horizontal or vertical wall mounting.

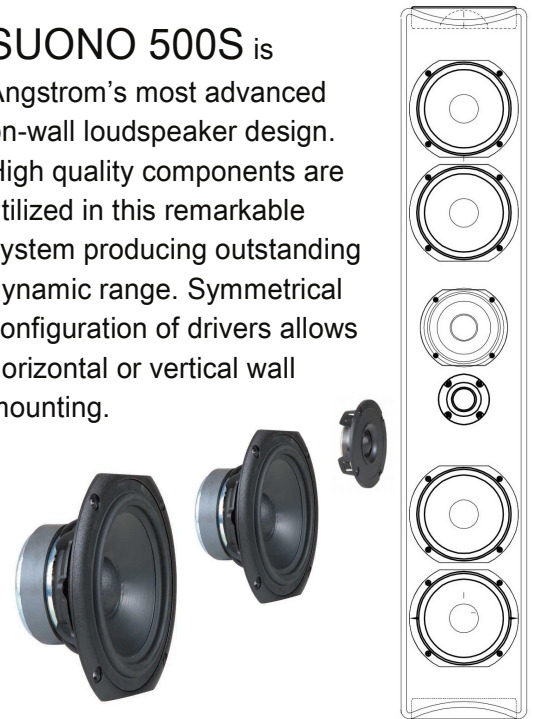

SPATIAL DIFFUSER (SD) technology is used in a design of Suono 100SD and Suono 600SD models. Their side-firing tweeters account for creating an extra wide sound field while playing movies or music.

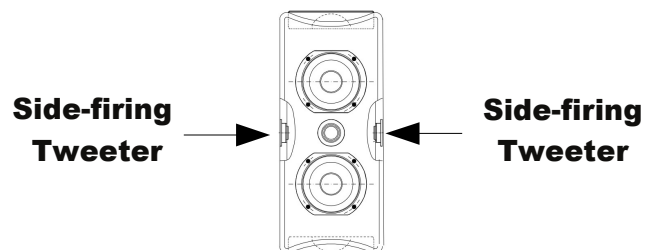

Technical Specifications

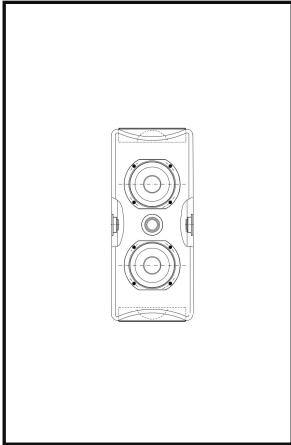

100SD Spatial Diffuser

Compact on-wall 2-way 5 drivers design. Dual 4" woofers, two side and one front 1" soft dome tweeters. Front tweeter is controlled by a toggle switch (0-6dB). All components tuned in MDF cabinet. Perfect for on-wall surround.

- Sensitivity: 86.5dB 1watt/1meter
- Power Handling: 100W
- Frequency: 60Hz-20kHz ± 3dB
- Dimensions: 16-1/4"H x 7"W x 3"D

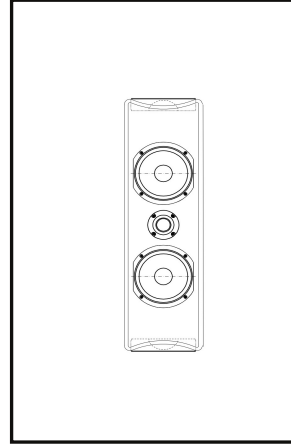

200S

2-way on-wall design with dual 4.5" woofers and one 1" soft dome tweeter. All components tuned in MDF cabinet. Perfect with 37"- 42" flat TV displays. Optional matching Plinths available.

- Sensitivity: 86dB 1 watt/1meter
- Power Handling: 100W
- Frequency: 60Hz – 20kHz ± 3dB
- Dimensions: 24"H x 7"W x 3"D

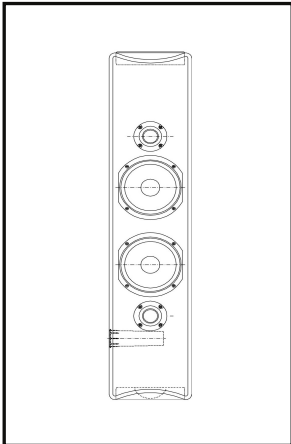

300S

2-1/2-way on-wall design with dual 4.5" woofers and dual 1" soft dome tweeters. All components tuned in MDF cabinet with single port. Ideal LCR combination for 46-60" flat TV displays. Optional matching Plinths available.

- Sensitivity: 87dB 1 watt /1 meter
- Power Handling: 120W
- Frequency: 55Hz – 20kHz ± 3dB
- Dimensions: 34"H x 7 "W x 3"D

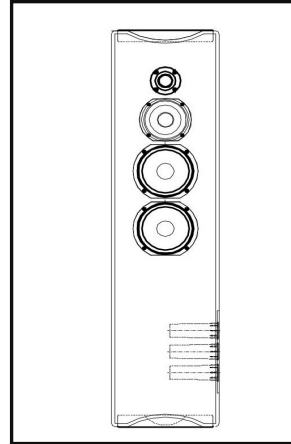

400 II

3-way on-wall or floor standing design with dual 4.5"woofers, one 4"midrange driver and one 1" soft dome tweeter. All components tuned in ported MDF Cabinet. Ideal for projector screens. Optional matching Plinths available.

- Sensitivity: 88dB 1watt / 1 meter
- Power Handling: 200W
- Frequency: 45Hz – 20kHz ± 3 dB
- Dimensions: 39"H x 10"W x 3"D

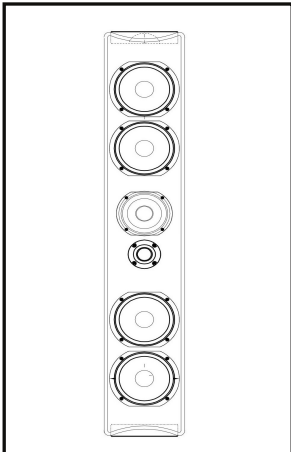

500S

3-way on-wall or floor standing design with four 4.5" woofers, one 4" midrange driver and one 1" soft dome tweeter. All components tuned in MDF cabinet. Ideal LCR solution for 72-80" flat TV's. Optional matching Plinths available.

- Sensitivity: 89dB 1watt / 1 meter
- Power Handling: 200W
- Frequency: 45Hz – 20kHz ± 3 dB
- Dimensions: 39"H x 7 "W x 3"D



600SD Spatial Diffuser

Specially designed pair performs as LCR. Two speakers as three. Top half contains a half center speaker with 4.5" woofer, 1"soft dome tweeter. Bottom half contains dual 4.5"woofers, 1" front and 1"side-firing soft dome tweeter. Ideal for 46-60 flat TV's.

- Sensitivity: 89dB 1watt / 1 meter
- Power Handling: 120W
- Frequency: 70Hz – 20kHz ± 3 dB
- Dimensions: 34"H x 7"W x 3"D



View all
of our
Models

ANGSTROM LOUDSPEAKERS MC

391 Marwood Drive, unit 6, Oshawa, Ontario L1H 7P8

Tel. (416) 988-8806

www.angstromloudspeakers.com